

Flush Rose  
Program





## Flush Rose Program

Reinforcing both FSB's minimal and modern design aesthetic, as well as our penchant for innovation, FSB proudly introduces flush hardware for swinging doors.

Once again FSB has designed an elegant way to incorporate our minimal European styling with ANSI (Grade 1) mortise locks and latches, as well as tubular and European locks and latches. With this groundbreaking introduction, FSB has decidedly proven that less is more.

Everyone in the construction industry will quickly realize that attaining design of this caliber requires both the best hardware, as well as the best door preparation available. FSB has proactively eliminated the concerns associated with the door preparation and installation process.

Hardware is pre-installed and tested at pre-authorized door suppliers to ensure the application looks and functions as well in the project as it does in design.

# Specifying Locksets

**1.**  
**1147**      –      **2.**  
**RJ**      –      **3.**  
**6204**      –      **4.**  
**SM**

## 1. Lever Design

The lever selection is indicated with a four-digit FSB Design number.

FSB stocks 44 levers in its North American distribution facility. 42 of these, as well as 23 others can be supplied with flush roses. Refer to page 4 to select your lever design and material.

If you are specifying a lock type or function which does not require a lever handle, begin your specification code with the trim set designation.

All details on specific finishes available are provided in the “Lever, Knob and Trim Designs” section of the North American Manual on each lever page. Please confirm the lever you have selected is offered in your desired finish.

## 2. Trim Set

To specify flush roses with the chosen lever design, use the trim set code provided below.

**RJ** Flush Rose  
2<sup>3</sup>/<sub>16</sub>" (55 mm)

Refer to page 6 of this program guide to see specific flush trim components.

**Please be advised that doors for flush trim can only be supplied through authorized door distributors.**

## 3. Material and Finish

While FSB stocks natural anodized aluminum and satin stainless steel in its North American distribution facility, FSB offers flush rose trim in thirteen different finishes, see the list and FSB code below.

- Aluminum Anodized**
  - 0105** Natural Color
  - 0205** German Silver (Champagne) Color
  - 0305** Brass Color
  - 0405** Bronze Color
  - 0704** Dark Bronze Color

- AluGrey Anodized**
  - 1005** Natural Color

- Stainless Steel**
  - 6204** Satin
  - 6205** Mirror Polished
  - 6206** Matte
  - 6210** Brass Color PVD

- Bronze**
  - 7305** Polished Oil Rubbed
  - 7615** Aged and Oil Rubbed
  - 7625** Patinated and Oil Rubbed

Please refer to any section of the North American Manual for more information regarding finishes.

## 4. Lock and Latch Type

The lock type is indicated with two capital letters.

See list below for available lock types which can be used with flush trim.

**SM** Standard Backset Mortise  
**EM** European Mortise

**HL** Heavy Duty Lever Latch  
**HD** Heavy Duty Privacy Deadbolt

**DS** Fixed Dummy Set

Available functions are dependent on lock type. With flush trim, not all functions are available for all lock types.

Refer to pages 7–11 of this program guide regarding lock types. More details about lock types are provided in the “Components” section of the North American Manual.

5. **C** — 6. **2 3/4"** — 7. **RHR** — 8. **1 3/4"**

**5. Lock and Latch Function**

The lock and latch functions as well as dummy sets are indicated with a letter.

See list below for available functions which can be used with flush trim.

- A** Store Door
- B** Dormitory
- C** Passage
- D** Hotel
- E** Privacy
  
- G** Classroom
- H** Entrance
- I** Office
- J** Storeroom
- J(EU)** Electrified (Fail Secure)
- J(EL)** Electrified (Fail Safe)
- K** Apartment
- M** Single Key Deadlock
- N** Key x Key Deadlock
- P** Key x Thumb Turn Deadlock
- R** Thumb Turn Deadlock
- S** Thumb Turn Deadlock with Emergency Release
  
- Y** Double Dummy (Back to Back)
- Z** Single Dummy

Trim sets are dependent on lock functions. **Not all functions are available.**

Refer to pages 7–10 of this program guide regarding available lock functions.

Refer to page 11 regarding dummies.

Example for Specifying:

1147 - RJ - 6204 - SM - C - 2 3/4" - RHR - 1 3/4"

**6. Backset**

FSB offers six different backsets for mortise locks and two for tubular latches, which will work with flush trim.

We stock both 2 1/2" and 2 3/4" backset ANSI mortise locks as well as 2 3/8" and 2 3/4" backset tubular latches.

We can supply the following backsets for flush trim:

Lock Type SM:  
**2 1/2", 2 3/4", 3 3/4", 5", 6"**

Lock Type EM:  
**55 mm (2 3/16")**

Latch Types HL:  
**2 3/8", 2 3/4"**

Deadbolt Types HD:  
**2 3/8", 2 3/4"**

**7. Handing**

Doors are either right hand (RH) or left hand (LH) inswinging or right hand reverse (RHR) or left hand reverse (LHR) outswinging, relative to which way they open. The hand of a door is always determined from the outside (locked side) of a door.

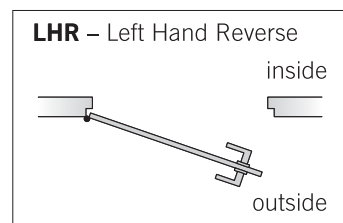
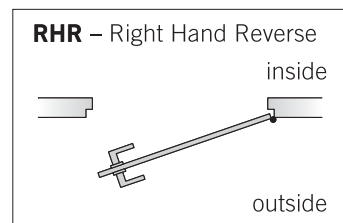
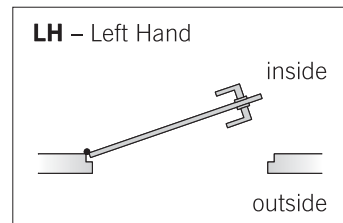
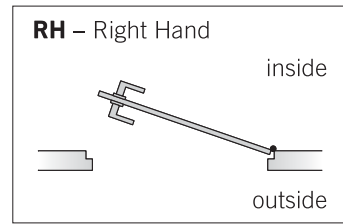

**8. Door Thickness**

FSB Flush Roses can only be used on 1 3/4" thick doors supplied by pre-approved door distributors.

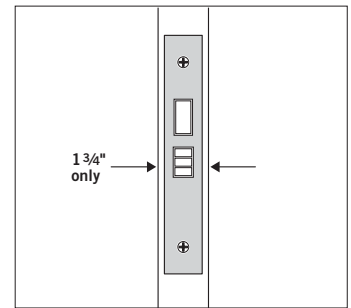

**1 3/4" only**

# Lever Designs

1001	1003	1004	1005	1007	1015
					
■	■ ■ ■ ■ ●	■ ■ ■ ■ ●	■ ■ ■ ■ ●	■	■ ■ ■ ■ ■ ●
1016	1020	1021	1023	1025	1027
					
■ ■ ■ ■ ●	■ ■	■ ■ ■ ■ ●	■ ■ ■ ■ ■ ●	■ ■ ■ ■ ●	■ ■ ■ ■ ●
1028	1029	1031	1034	1035	1045
					
■ ■ ■ ■ ●	■ ■	■ ■ ■ ■ ●	■ ■	■ ■ ■ ■ ●	■ ■ ■ ■ ■ ●
1051	1053	1057	1058	1063	1064
					
■ ■	■ ■ ■ ■ ■ ●	■ ■ ■ ●	■ ■ ■ ●	■ ■ ■ ■ ■	■ ■ ■ ■ ■
1070	1074	1075	1076	1077	1078
					
■ ■ ■ ■ ●	■ ■ ■ ●	■ ■ ■ ■ ●	■ ■ ■ ■ ●	■ ■ ■ ■ ■ ●	■ ■ ■ ■ ●
1080	1082	1088	1089	1093	1094
					
■ ■ ■ ●	■ ■ ■ ■ ■	■ ■ ■ ■ ●	■ ■ ■ ■ ●	■ ■ ■ ■ ●	■ ■ ■ ■ ●

Base Material  
 □ Aluminum  
 □ AluGrey  
 □ Stainless Steel  
 ■ Bronze  
 ■ Plastic Black  
 ■ Wood

● Stock Items  
 (in Natural Color  
 Aluminum and Satin  
 Stainless Steel)

1102	1106	1107	1108	1111	1114
□ □ ■ □ ■ ●	□ □ ■ ■ ●	□ □ ■ ●	□ □ ■ ●	□	■
1118	1119	1126	1128	1134	1144
□ ■ ●	□ □ ■ ●	■	■	□ ■ ■ ●	□ □ ■ ●
1146	1147	1160	1171	1173	1176
□ □ ■ ●	□ □ ■ ●	□ □ ■ ●	□ □ ■ ●	□ □ ■ ●	□ □ ■ ●
1177	1178	1180	1182	1183	1194
□ □ ■ ●	□ □ ■ ●	□	□	□ ■ ●	■
1197	1208	1209	1211	1212	
■	■ ■		■ ■		

# Trim Set RJ

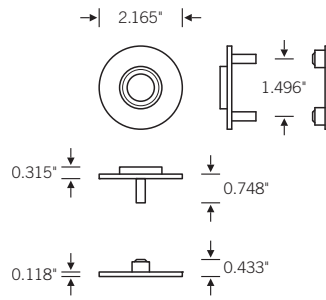

**Flush Roses**  
0.118" (3 mm) ×  
2.165" (55 mm)

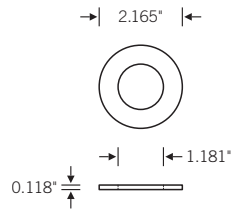

**Cylinder Ring**  
0.118" (3 mm) ×  
2.165" (55 mm)

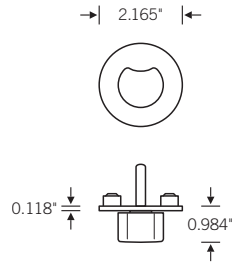

**Thumbturn and  
Emergency Release  
(with Indicator as standard)**  
0.118" (3 mm) ×  
2.165" (55 mm)

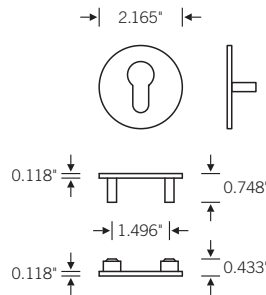

**European Cylinder Ring**  
0.118" (3 mm) ×  
2.165" (55 mm)

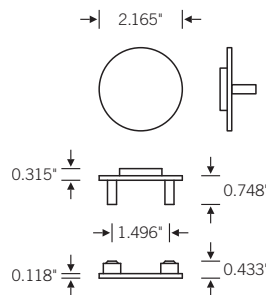

**Blind Rose**  
0.118" (3 mm) ×  
2.165" (55 mm)

# Lock Types for Flush Roses

---



## Series SM

Standard Backset  
Mortise Lock

**Federal Specifications**  
ANSI A 156.13, Series 1000,  
Grade 1

**Backsets**  
2½" (64 mm)  
2¾" (70 mm)  
3¾" (95 mm)  
5" (127 mm)  
6" (152 mm)



## Series EM

European Mortise Lock  
(without Emergency Egress)

**Specifications**  
DIN Grade 2 Mortise Lock  
field reversible

**Backset**  
55 mm (2.156") only



## Series HL

Heavy Duty Lever Latch  
Passage only

**Specifications**  
Field reversible with adjustable  
bevel (½" over 2")

**Backsets**  
2¾" (60 mm) and 2¾" (70 mm)



## Series HD

Heavy Duty Privacy Deadbolt

**Specifications**  
Full bolt extension achieved  
with 90° thumbturn rotation

**Backsets**  
2¾" (60 mm) and 2¾" (70 mm)



## Series DS

Fixed Dummy Sets

---

UL Rating not available with  
Flush Roses.  
Applied for with SM Series.

# Standard Backset Mortise Lock Series SM Functions



## Flush Trim

Combined with Series **SM** limited Functions below.

Set screw can be moved to the bottom of the lever (optional).



**Function B**  
Dormitory

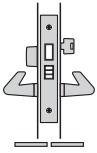

ANSI Code F13

**Function C**  
Passage

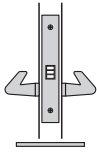

ANSI Code F01

**Function D**  
Hotel

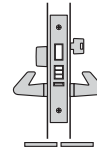

ANSI Code F15

**Function E**  
Privacy

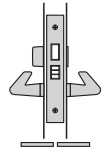

ANSI Code F19

**Function G**  
Classroom

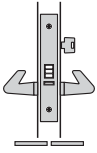

ANSI Code F05

**Function H**  
Entrance



ANSI Code F12

**Function I**  
Office

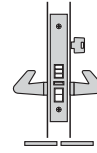

ANSI Code F04

**Function J**  
Storeroom

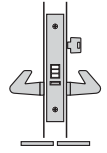

ANSI Code F07

**Function J(EU)  
or J(EL)**

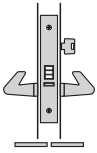

Electrified  
Storeroom

**Function K**  
Apartment

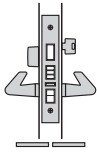

ANSI Code F20

**Function M**  
Single Key  
Deadlock

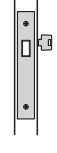

ANSI Code F18

**Function P**  
Key x Thumbturn  
Deadlock

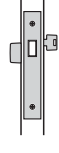

ANSI Code F17

**Function R**  
Thumbturn  
Deadlock

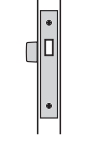

**Function S**  
Thumbturn  
Deadlock with  
Emergency  
Release

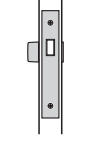

### Top View Series **SM**

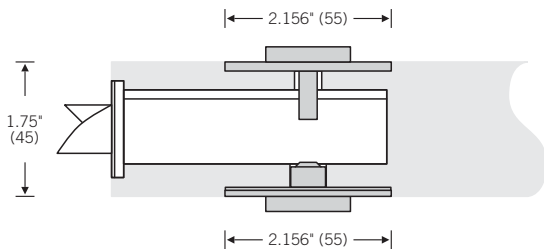

# European Mortise Lock Series EM Functions



## Flush Trim

Combined with Series **EM**  
limited Functions below.

Set screw can be moved to the  
bottom of the lever (optional).



**Function A**  
Store Door



**Function B**  
Dormitory



**Function C**  
Passage

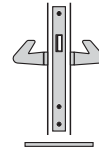

**Function E**  
Privacy

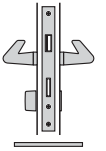

**Function N**  
Key x Key  
Deadbolt

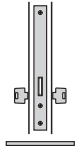

**Function P**  
Key x Thumbturn  
Deadbolt

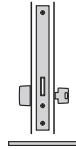

## Top View Series **EM**

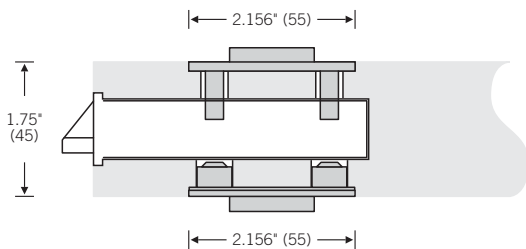

# Heavy Duty Tubular Latch Heavy Duty Privacy Deadbolt Series HL and HD Functions



**Function C**  
Passage

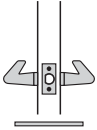

## Flush Trim

Combined with Series **HL**  
limited Function below.

Set screw can be moved to the  
bottom of the lever (optional).



**Function R**  
Mortise Bolt with  
Thumbturn



**Function S**  
Mortise Bolt with  
Thumbturn and  
Emergency  
Release



## Flush Trim

Combined with Series **HD**  
limited Function below.

Set screw can be moved to the  
bottom of the lever (optional).

**Function R** will be supplied with  
wood screws.



Top View Series **HL**

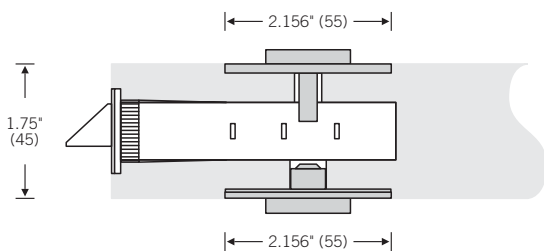

Top View Series **HD**

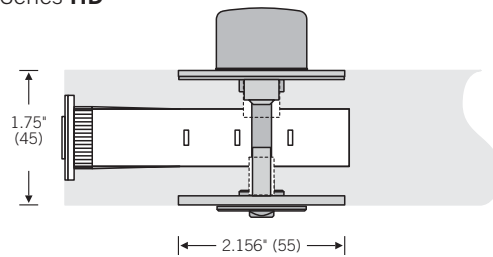

# Fixed Dummy Mounts DS-Y and DS-Z



## Flush Trim

Combined with Fixed Dummy Mount **DS**.

Set screw can be moved to the bottom of the lever (optional).



**Function DS-Y**  
Fixed Double  
Dummy

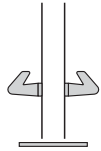

**Function DS-Z**  
Fixed Single  
Dummy

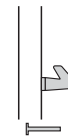

Top View Series **DS-Y**

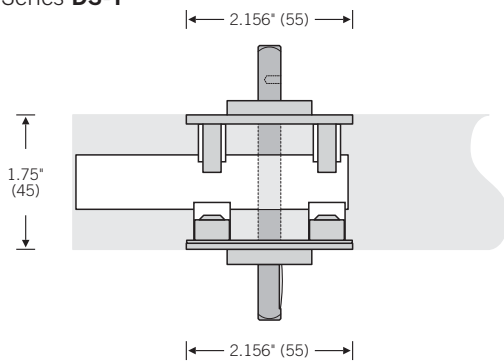

Top View Series **DS-Z**

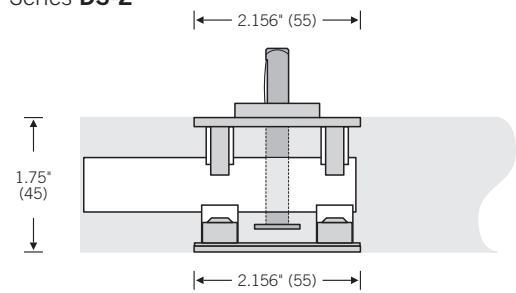







North America

1 Bishop Lane  
Madison, CT 06443

Tel 203 404 4700  
Fax 203 404 4710

[www.fsbna.com](http://www.fsbna.com)  
[info@fsbna.com](mailto:info@fsbna.com)