

Türzubehör

Türbänder VX	6.02-9
Wand-Türpuffer	6.03-9
Boden-Türpuffer	6.04-9
Zahlen und Buchstaben	6.05-9
Türfunktionsschilder	6.06-9

Accessories

Hinges VX	6.02-9
Wall mounted door stops	6.03-9
Floor mounted door stops	6.04-9
Numbers and letters	6.05-9
Push/pull symbols	6.06-9

Kurzzeichen Türbänder VX

ER Edelstahl Rostfrei
TB Türband

Identification hinges VX

ER Stainless steel
TB Hinge

Bestellnummern-System

Explanation of product code

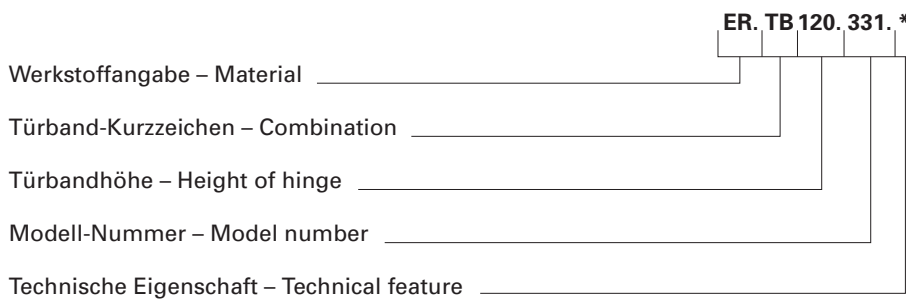

* **S** = stumpf
F = überfäلت
SI = Sicherung
T = Tragbolzen

* **S** = standard
F = rebated
SI = security screw
T = carrying bolts

Modellübersicht Türbänder VX – Edelstahl

Vieler hinges VX – stainless steel

VX 120 S

6.02-9

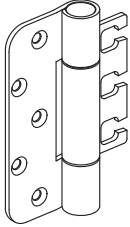

VX 120 F

6.02-9

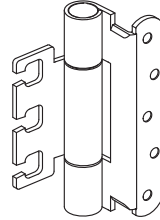

VX 160 S

6.02-9

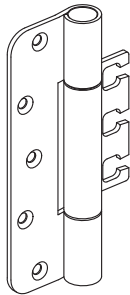

VX 160 F

6.02-9

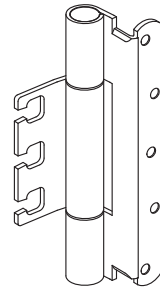



Vieler Türbänder VX – Edelstahl
Vieler hinges VX – stainless steel

● = Bandbezugslinie
= Centre line for installation

Türband VX 120 S

Für stumpfe Türen, optional mit Stiftsicherung und Tragbolzen. Je ein mittiger Tragbolzen Ø 12 mm, 60 mm lang, pro Band. Senkbohrungen Ø 6 / Ø 10,5 mm x 90° für Senkholzschrauben Ø 5 x 50 mm. Zulässiges Türgewicht 160 kg, Referenz für 2 Türbänder.



Hinge VX 120 S

For standard doors, with or without protection screw and carrying bolts. One carrying bolt each hinge, centrally, Ø 12 mm, length 60 mm, drillings Ø 6 / Ø 10,5 mm x 90° for wood screws Ø 5 x 50 mm. Max door weight 160 kg, (2 hinges each door)

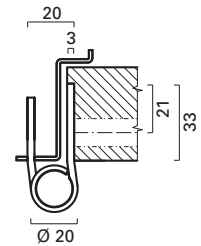
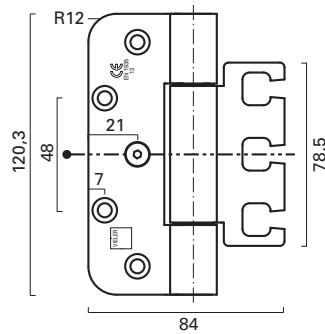

STRIMA
Frässhablone 11813504
template 11813504

Türband VX 120 F

Für gefälzte Türen, optional mit Stiftsicherung und Tragbolzen. Je ein mittiger Tragbolzen Ø 12 mm, 60 mm lang, pro Band. Senkbohrungen Ø 6 / Ø 10,5 mm x 90° für Senkholzschrauben Ø 5 x 50 mm. Zulässiges Türgewicht 160 kg, Referenz für 2 Türbänder.



Hinge VX 120 F

For rebated doors, with or without protection screw and carrying bolts. One carrying bolt each hinge, centrally, Ø 12 mm, length 60 mm, drillings Ø 6 / Ø 10,5 mm x 90° for wood screws Ø 5 x 50 mm. Max door weight 160 kg, (2 hinges each door)

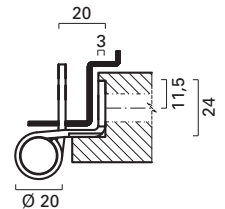
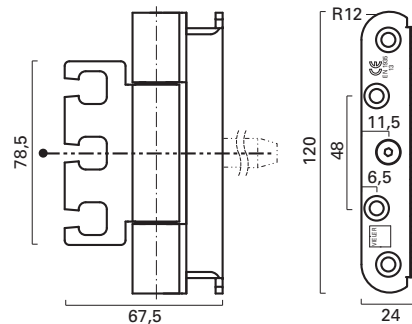

STRIMA
Frässhablone 11813501
template 11813501

Türband VX 160 S

Für stumpfe Türen, optional mit Stiftsicherung und Tragbolzen. Je ein mittiger Tragbolzen Ø 12 mm, 60 mm lang, pro Band. Senkbohrungen Ø 6 / Ø 10,5 mm x 90° für Senkholzschrauben Ø 5 x 50 mm. Zulässiges Türgewicht 260 kg, Referenz für 2 Türbänder.



Hinge VX 160 S

For standard doors, with or without protection screw and carrying bolts. One carrying bolt each hinge, centrally, Ø 12 mm, length 60 mm, drillings Ø 6 / Ø 10,5 mm x 90° for wood screws Ø 5 x 50 mm. Max door weight 260 kg, (2 hinges each door)

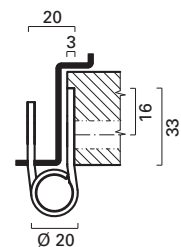
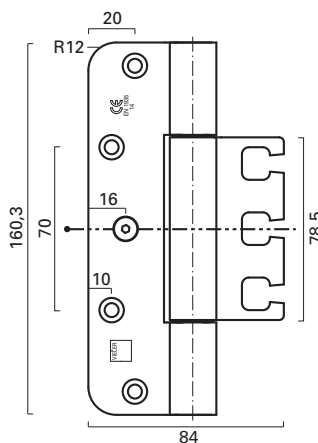

STRIMA
Frässhablone 11813512
template 11813512

Türband VX 160 F

Für gefälzte Türen, optional mit Stiftsicherung und Tragbolzen. Je ein mittiger Tragbolzen Ø 12 mm, 60 mm lang, pro Band. Senkbohrungen Ø 6 / Ø 10,5 mm x 90° für Senkholzschrauben Ø 5 x 50 mm. Zulässiges Türgewicht 260 kg, Referenz für 2 Türbänder.



Hinge VX 160 F

For rebated doors, with or without protection screw and carrying bolts. One carrying bolt each hinge, centrally, Ø 12 mm, length 60 mm, drillings Ø 6 / Ø 10,5 mm x 90° for wood screws Ø 5 x 50 mm. Max door weight 260 kg, (2 hinges each door)

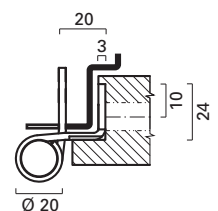
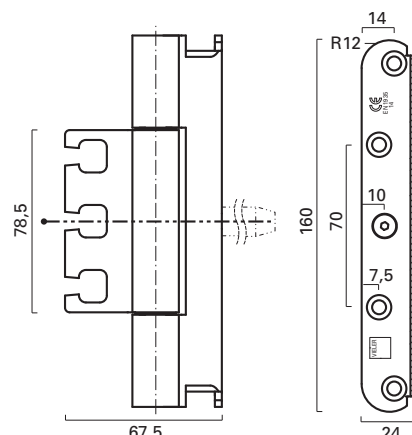

STRIMA
Frässhablone 11813524
template 11813524

Bezugsquelle Frässhablonen:
Source of supply templates:

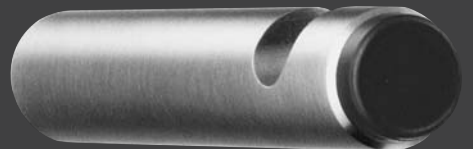
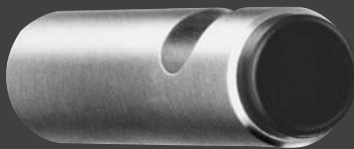
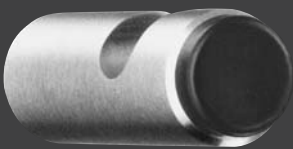
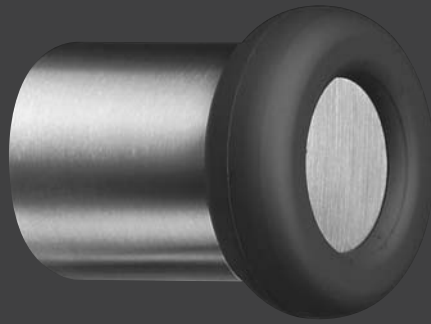

Vieler Wand-Türpuffer – Edelstahl

Hochwertiges Material mit matt gebürsteter, pflegeleichter Oberfläche. Gummi schwarz.

Vieler wall mounted door stops – stainless steel

Maintenance free brushed satin stainless steel. Black rubber.

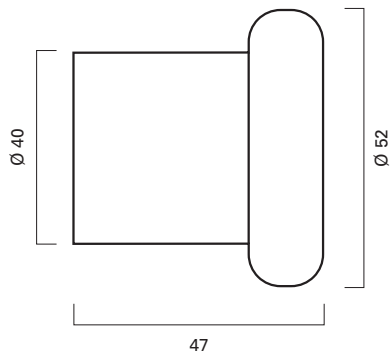

ER.TP.5121

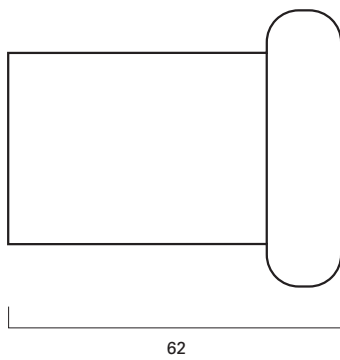

ER.TP.5122

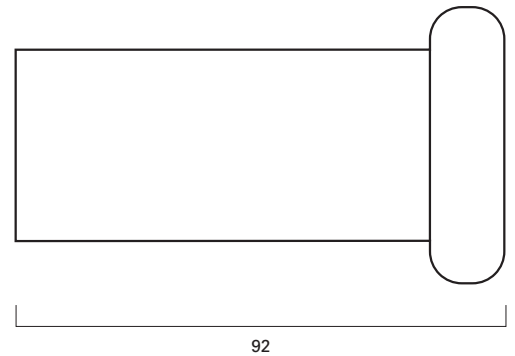

ER.TP.5123

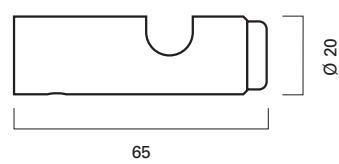

ER.TP.6533

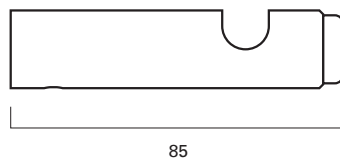

ER.TP.6537

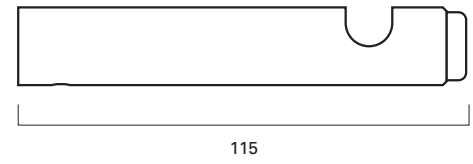

ER.TP.6538

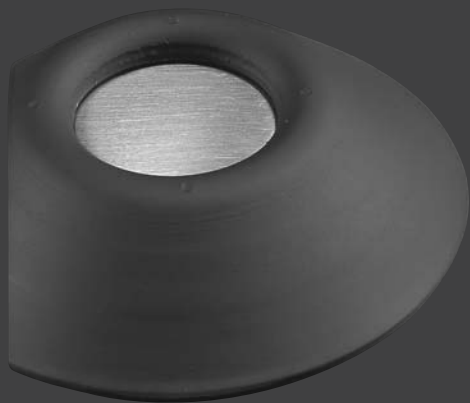

Vielser Boden-Türpuffer – Edelstahl

Hochwertiges Material mit matt gebürsteter, pflegeleichter Oberfläche. Gummi schwarz.

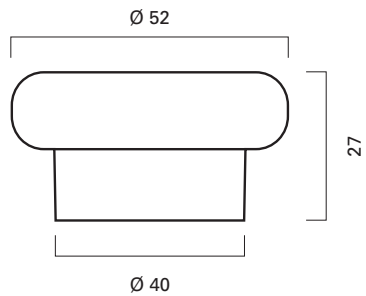

ER.TP.5120

Vielser floor mounted door stops – stainless steel

Maintenance free brushed satin stainless steel. Black rubber.

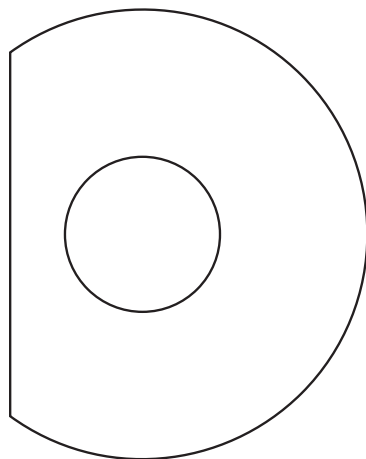
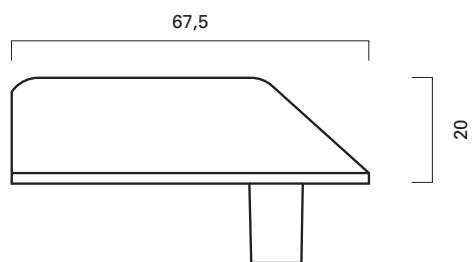

ER.TP.5103

17

a

Vieler Zahlen und Buchstaben – Edelstahl

Hochwertiges Material, 3 mm dick, mit matt gebürsteter, pflegeleichter Oberfläche. Schrifthöhe 150 und 200 mm.

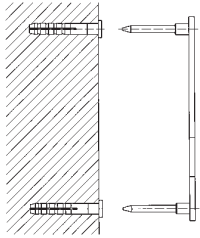

			B	H
1	150	ER.HN150.1	67	150
	200	ER.HN200.1	90	200
2	150	ER.HN150.2	104	150
	200	ER.HN200.2	139	200
3	150	ER.HN150.3	100	150
	200	ER.HN200.3	134	200
4	150	ER.HN150.4	114	150
	200	ER.HN200.4	152	200
5	150	ER.HN150.5	103	150
	200	ER.HN200.5	138	200
6	150	ER.HN150.6	103	150
	200	ER.HN200.6	138	200
7	150	ER.HN150.7	97	150
	200	ER.HN200.7	129	200
8	150	ER.HN150.8	104	150
	200	ER.HN200.8	138	200
9	150	ER.HN150.9	103	150
	200	ER.HN200.9	138	200
0	150	ER.HN150.0	101	150
	200	ER.HN200.0	135	200
/	150	ER.HN150.11	67	150
	200	ER.HN200.11	88	200
-	150	ER.HN150.12	57	23
	200	ER.HN200.12	66	30
□	150	ER.HN150.13	27	27
	200	ER.HN200.13	35	35

Vieler numbers and letters – stainless steel

Maintenance free brushed satin stainless steel. 3 mm thick, type size 150 and 200 mm.

			B	H
a	150	ER.KB150.A	95	111
	200	ER.KB200.A	127	148
b	150	ER.KB150.B	109	150
	200	ER.KB200.B	146	200
c	150	ER.KB150.C	93	111
	200	ER.KB200.C	124	148
d	150	ER.KB150.D	109	150
	200	ER.KB200.D	146	200
e	150	ER.KB150.E	101	111
	200	ER.KB200.E	135	148
A	150	ER.GB150.A	144	150
	200	ER.GB200.A	192	200
B	150	ER.GB150.B	117	150
	200	ER.GB200.B	156	200
C	150	ER.GB150.C	121	150
	200	ER.GB200.C	161	200
D	150	ER.GB150.D	127	150
	200	ER.GB200.D	169	200
E	150	ER.GB150.E	103	150
	200	ER.GB200.E	137	200



Vieler Türfunktionsschilder – Edelstahl

Hochwertiges Material, 1 mm dick, mit matt gebürsteter, pflegeleichter Oberfläche, selbstklebend.



ER.TF.0630



ER.TF.0631

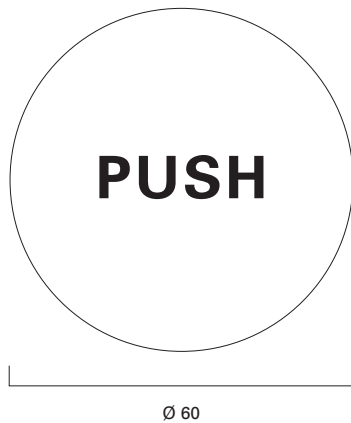

ER.TF.0632

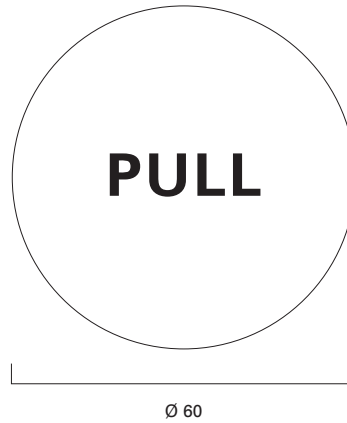

ER.TF.0633

Vieler push/pull symbols – stainless steel

Maintenance free brushed satin stainless steel. 1 mm thick, self-adhesive.